Report 8 - Interpolating Sweep

Msc. Damian Szypulski
November 23, 2018



European Union
European Regional
Development Fund



The „EDISON - Electromagnetic Design of flexible SensOrs” project, agreement no TEAM TECH/2016-1/6, is carried out within the TEAM-TECH programme of the Foundation for Polish Science co-financed by the European Union under the European Regional Development Fund.

Revision	Date	Author(s)	Description
1.0	22.08.2017		created

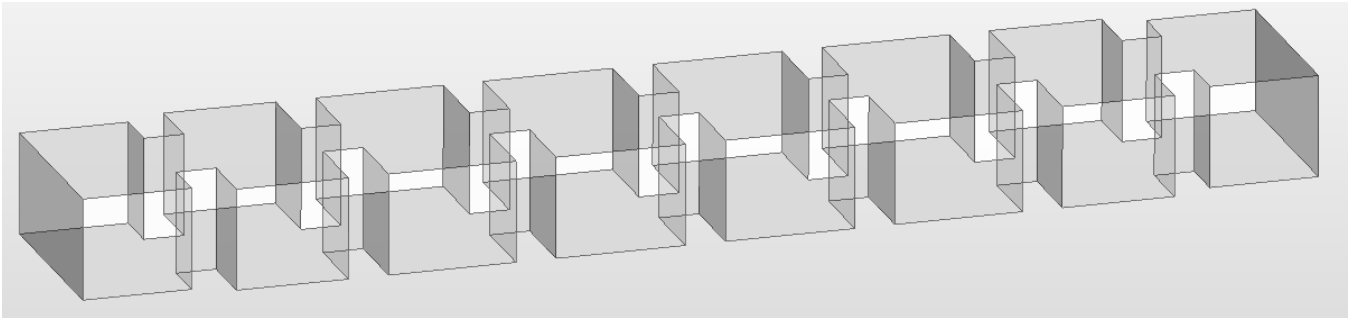

Figure: H-Plane filter

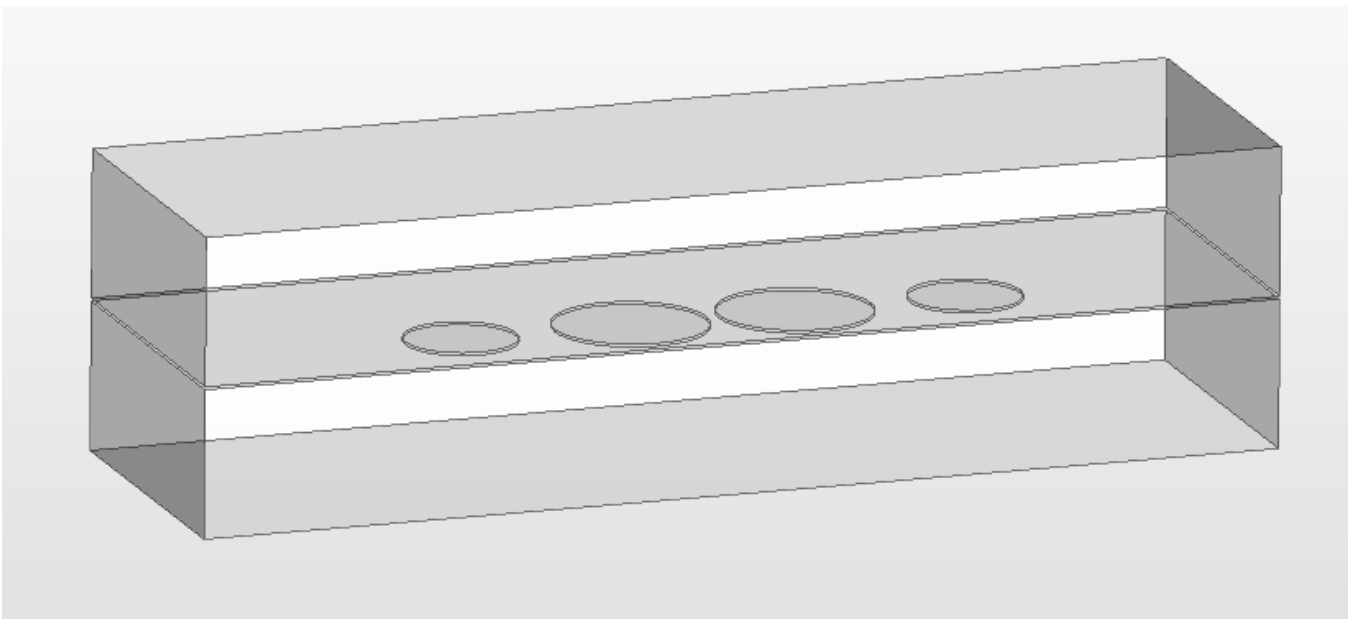

Figure: Coupler 4 holes

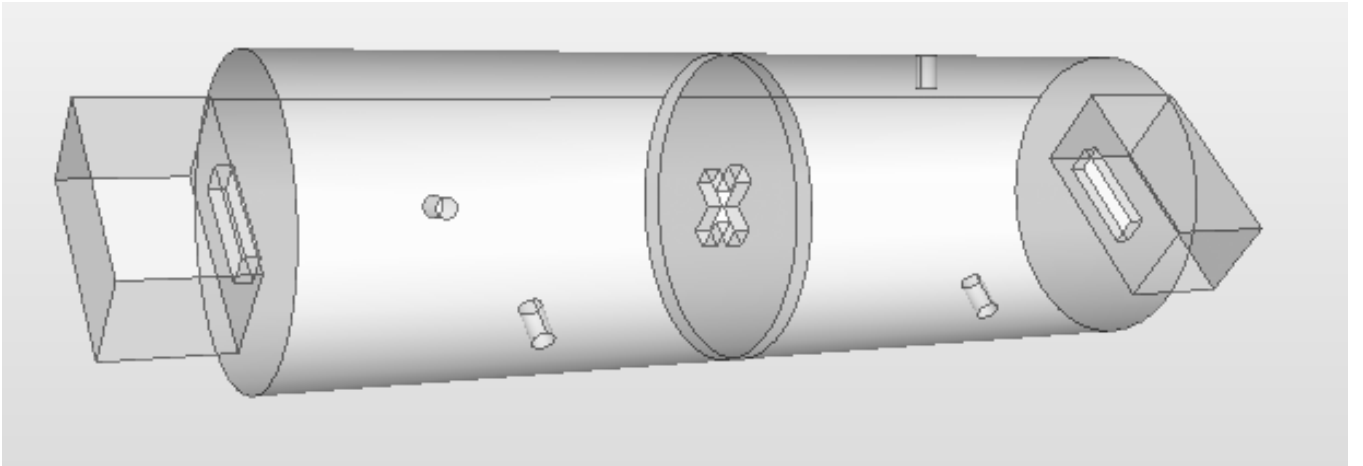

Figure: Dual mode 170k

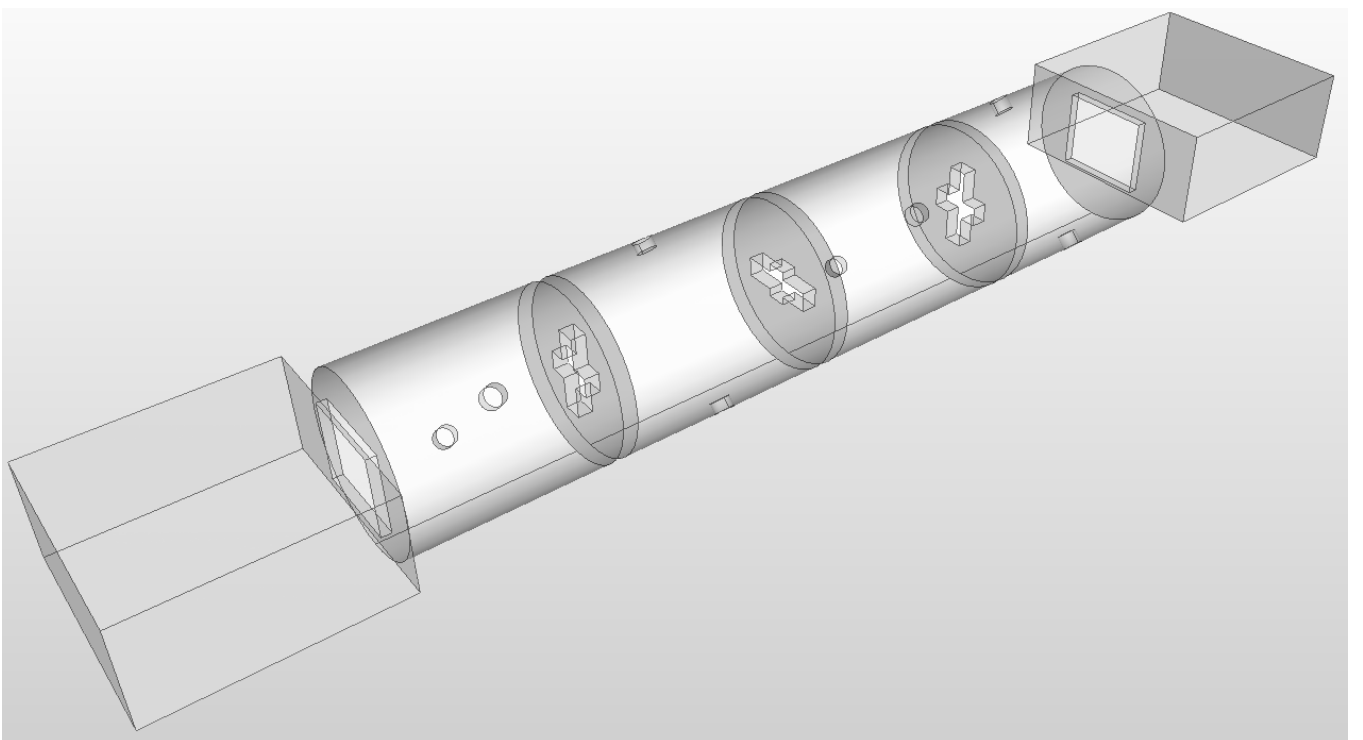
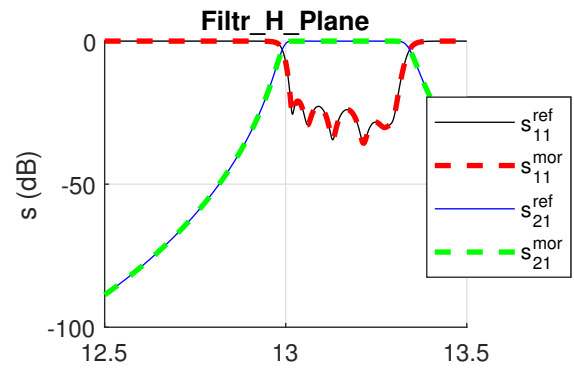
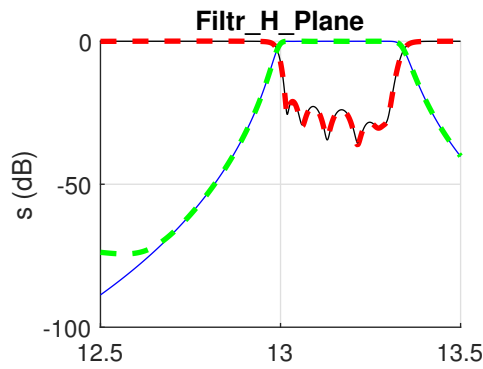
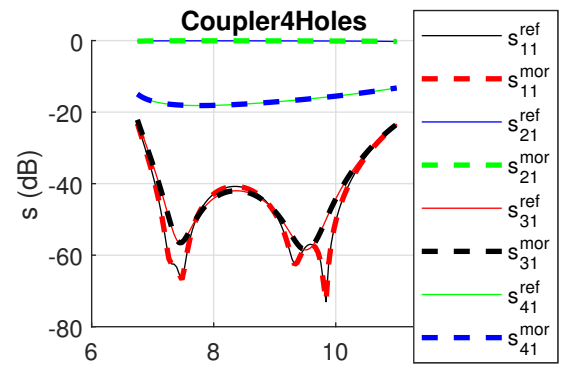
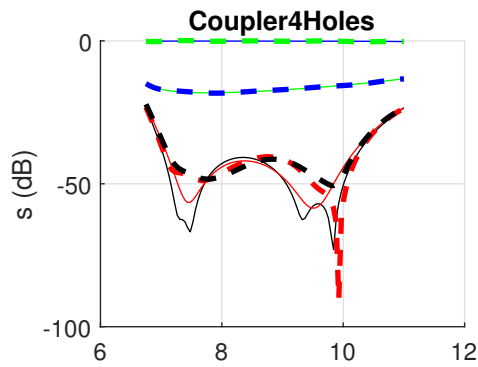
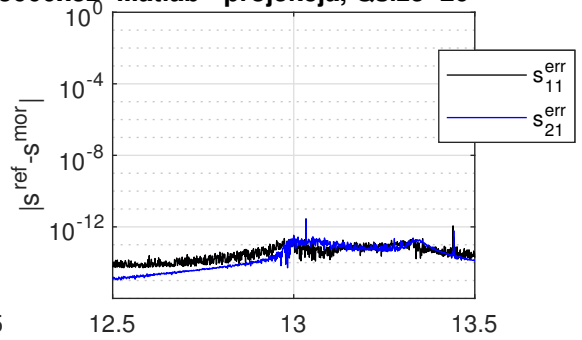
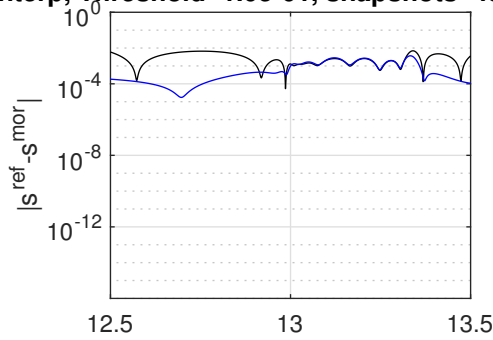

Figure: Eight order dual mode



interp, Threshold=1.0e-01, snapshots=43600x32 Matlab - projekcja, Qsize=20



interp, Threshold=1.0e-01, snapshots=52678x44 Matlab - projekcja, Qsize=40

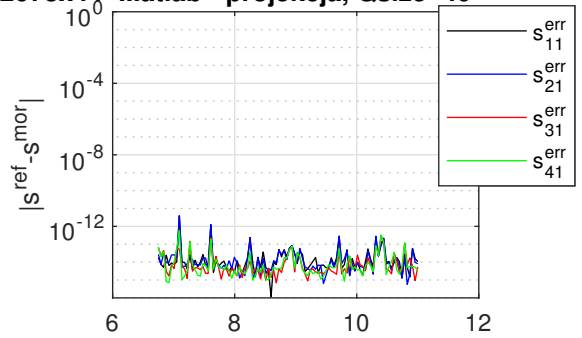
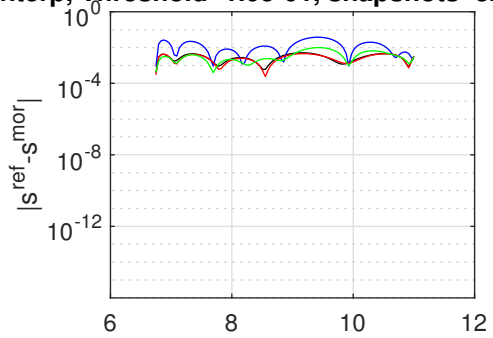

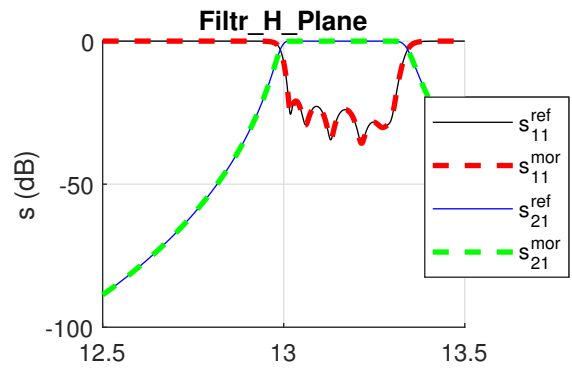
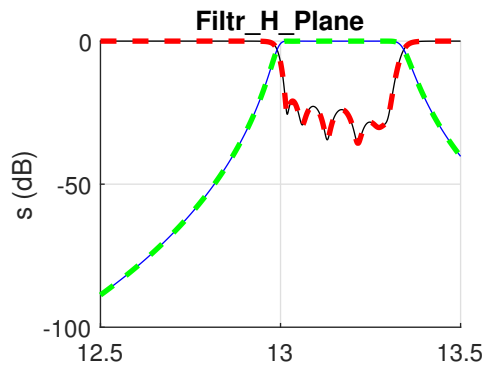

interp, Threshold=1.0e-02, snapshots=43600x34 Matlab - projekcja, Qsize=20

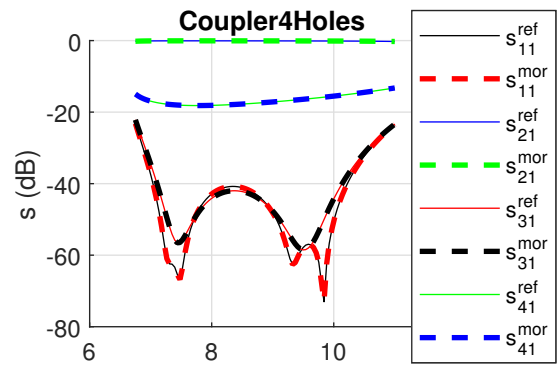
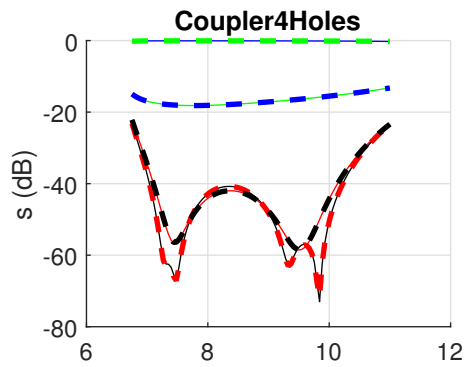
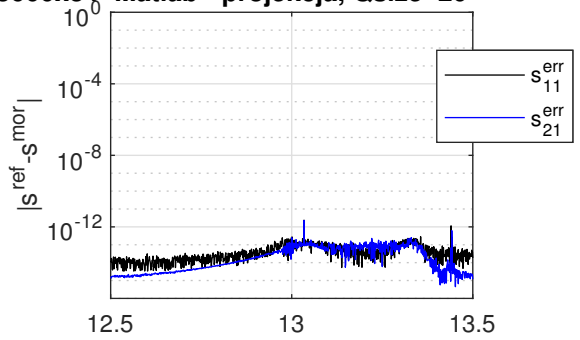
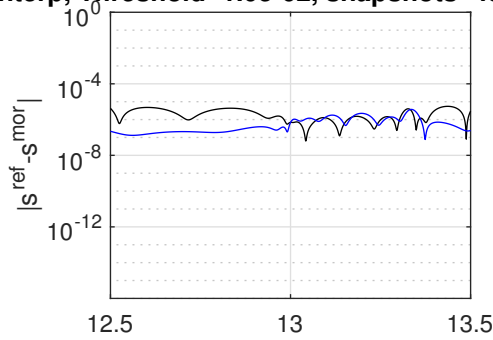

interp, Threshold=1.0e-02, snapshots=52678x60 Matlab - projekcja, Qsize=44

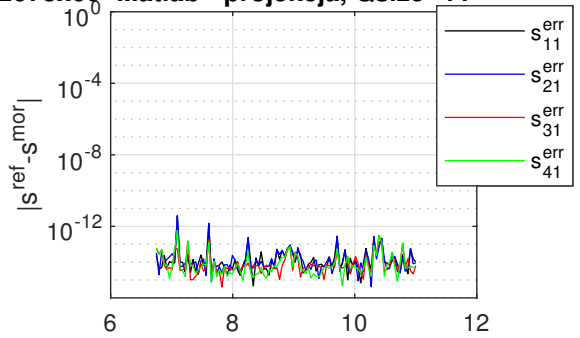
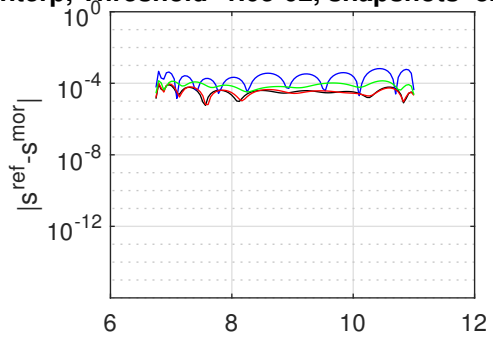

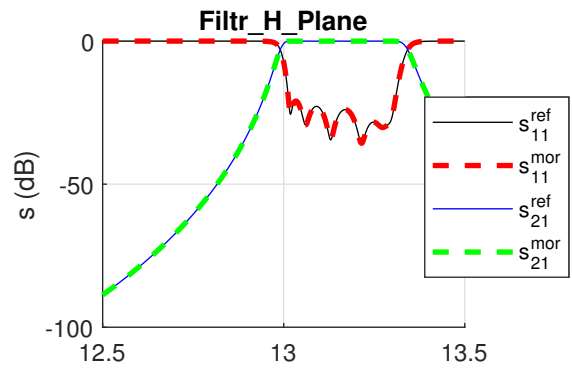
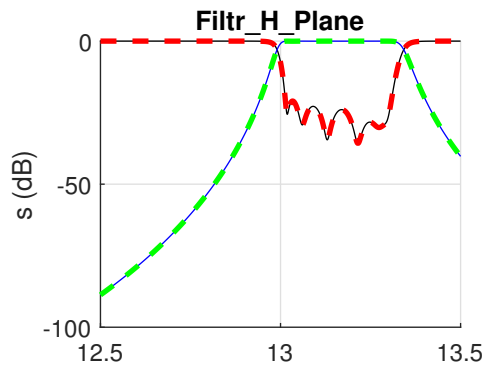

interp, Threshold=1.0e-03, snapshots=43600x38 Matlab - projekcja, Qsize=20

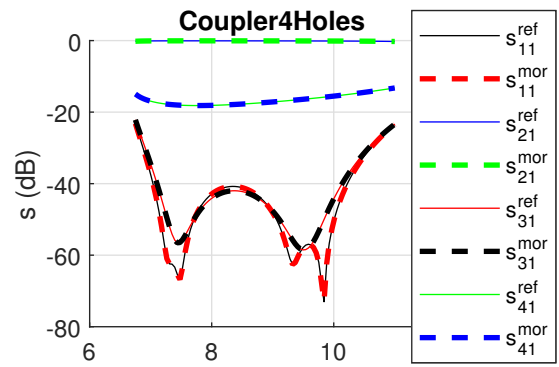
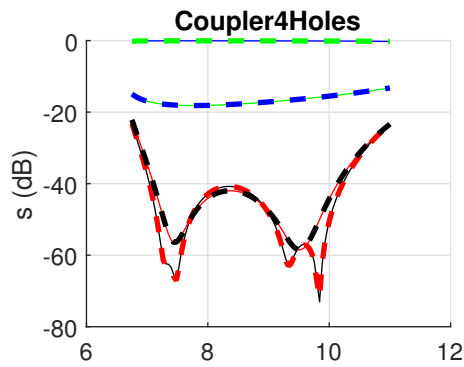
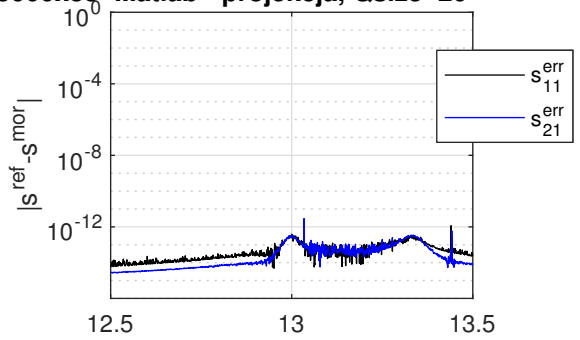
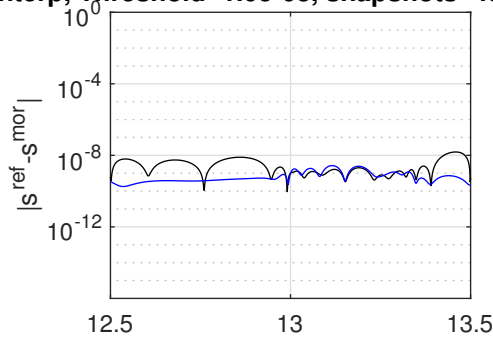

interp, Threshold=1.0e-03, snapshots=52678x60 Matlab - projekcja, Qsize=44

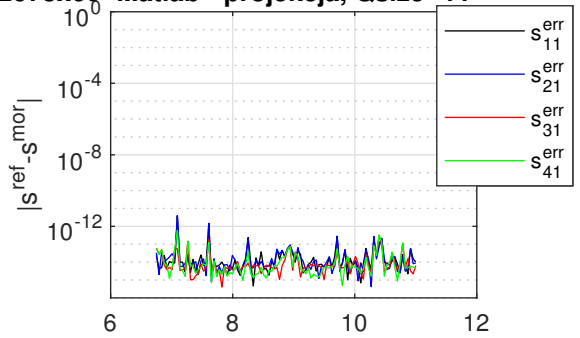
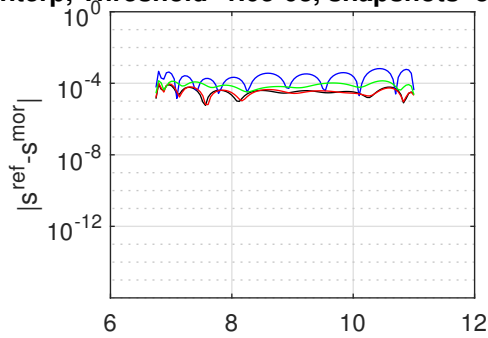

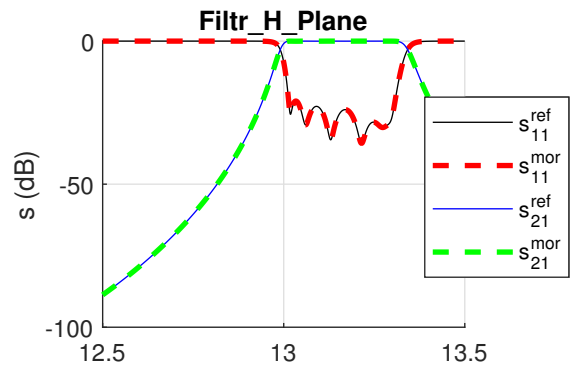
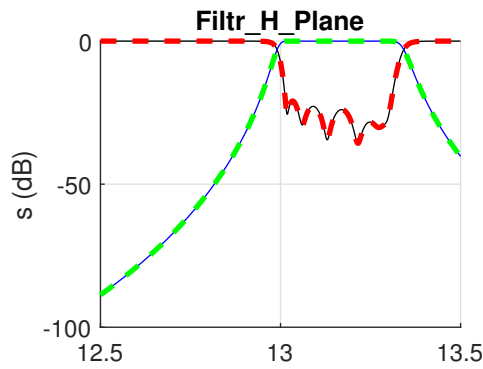

interp, Threshold=1.0e-04, snapshots=43600x38 Matlab - projekcja, Qsize=20

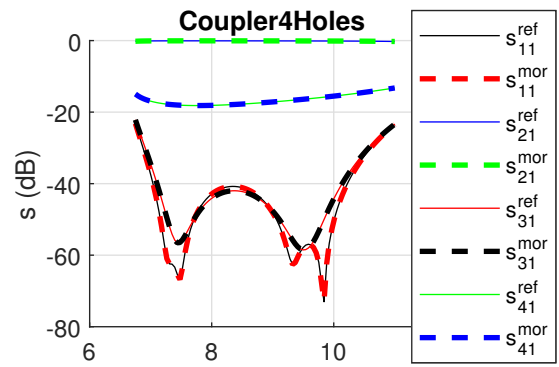
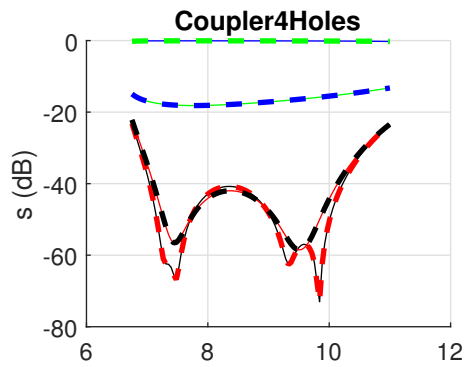
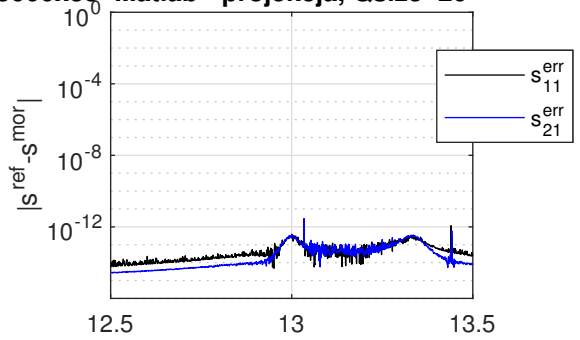
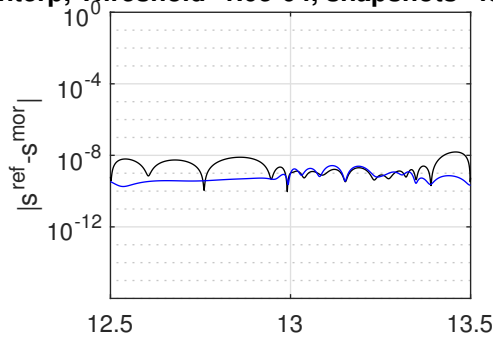

interp, Threshold=1.0e-04, snapshots=52678x84 Matlab - projekcja, Qsize=47

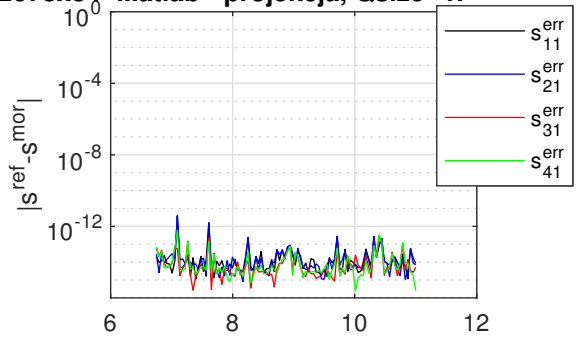
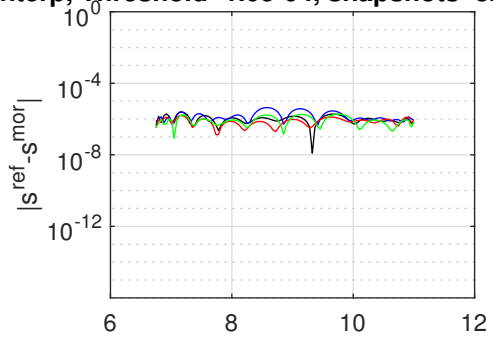

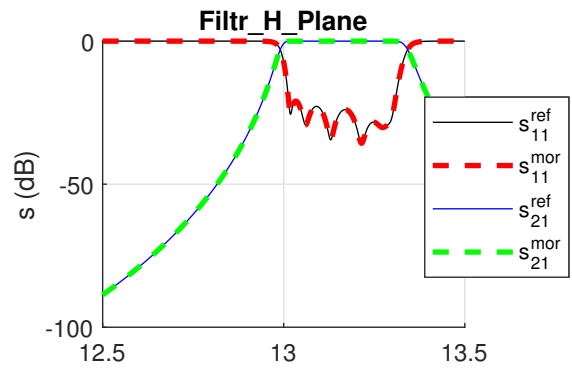
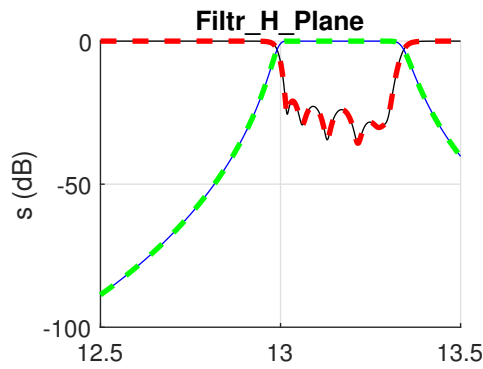

interp, Threshold=1.0e-05, snapshots=43600x38 Matlab - projekcja, Qsize=20

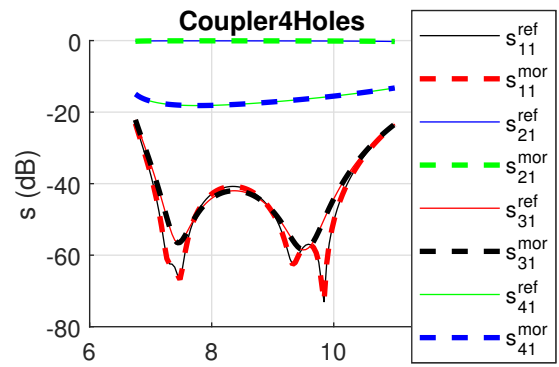
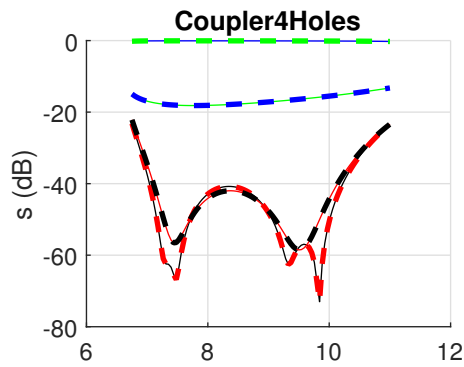
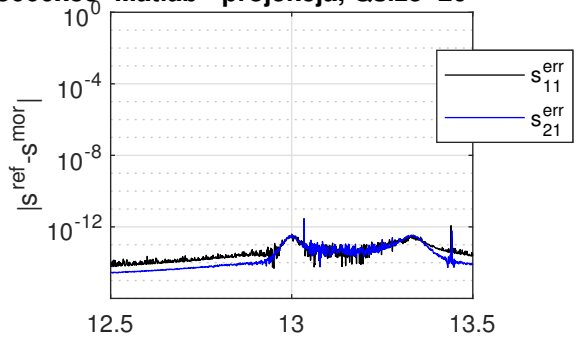
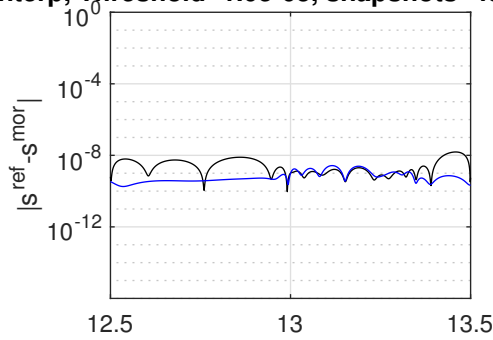

interp, Threshold=1.0e-05, snapshots=52678x92 Matlab - projekcja, Qsize=47

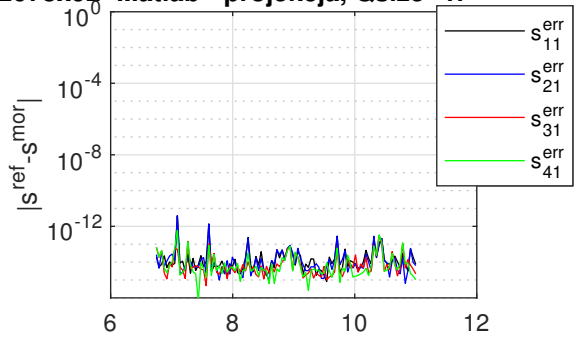
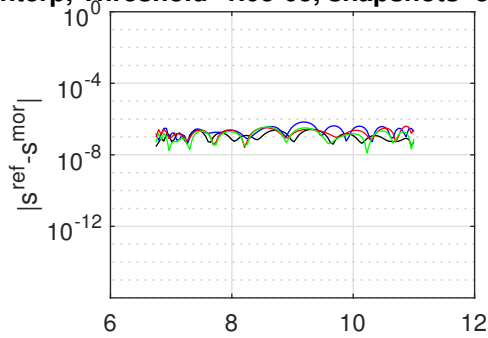

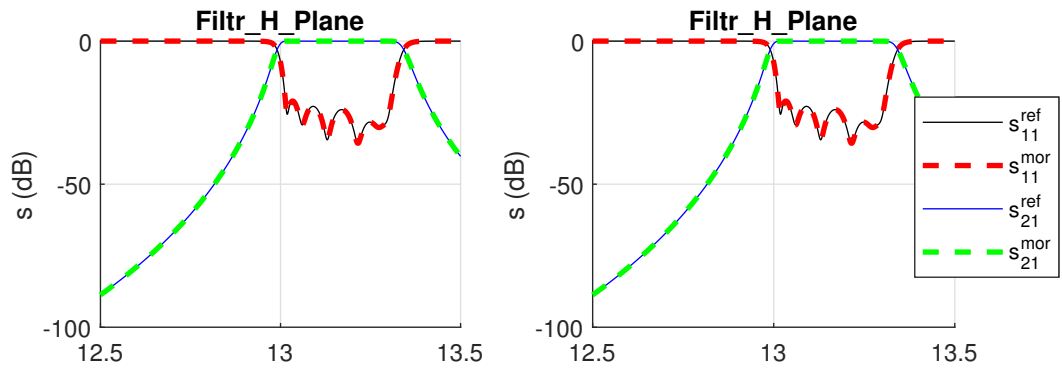

interp, Threshold=1.0e-06, snapshots=43600x42 Matlab - projekcja, Qsize=20

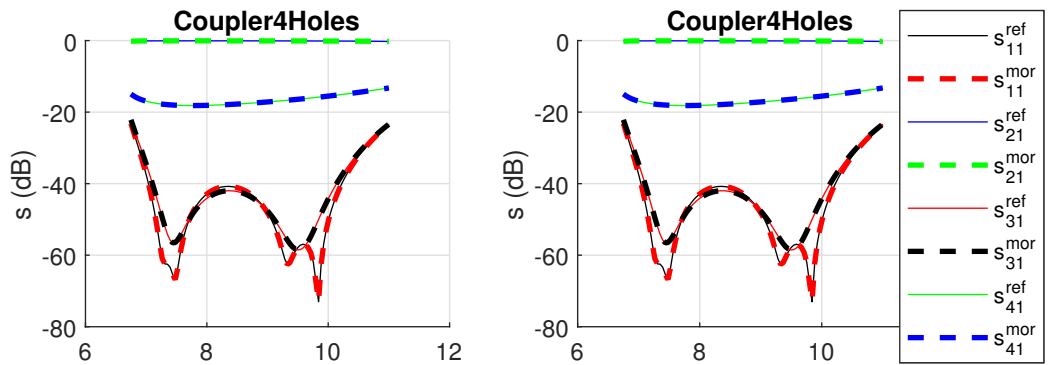
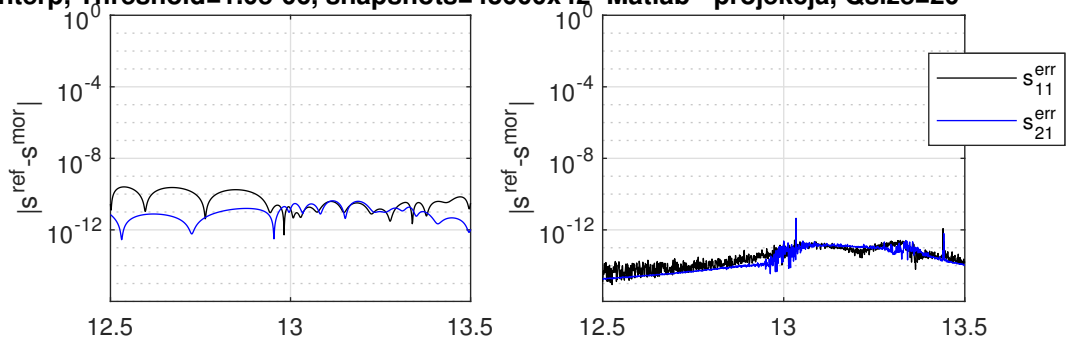

interp, Threshold=1.0e-06, snapshots=52678x100 Matlab - projekcja, Qsize=47

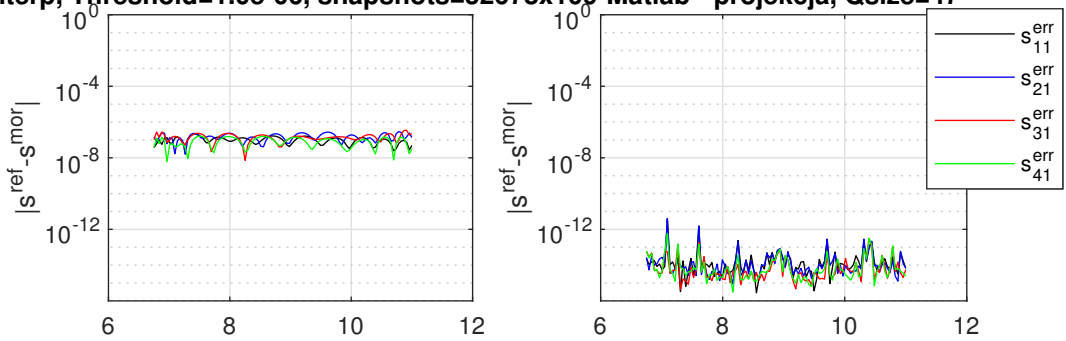

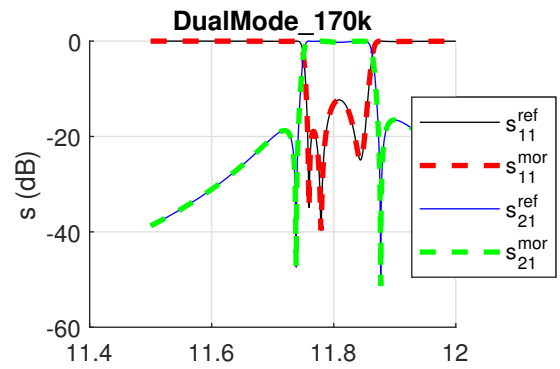
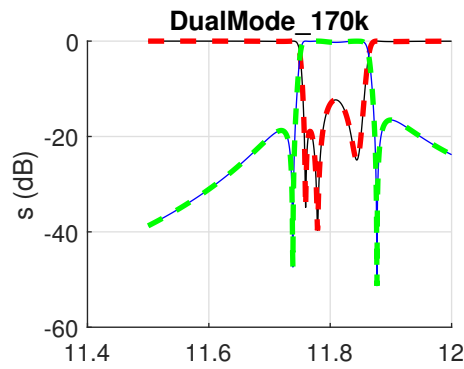

interp, Threshold=1.0e-01, snapshots=123288x26 Matlab - projekcja, Qsize=23

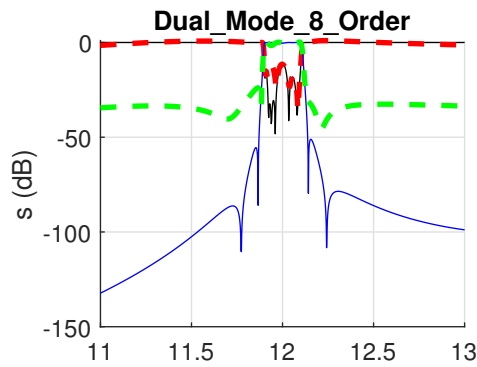
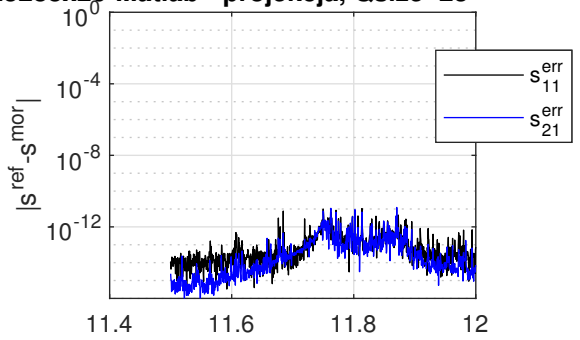
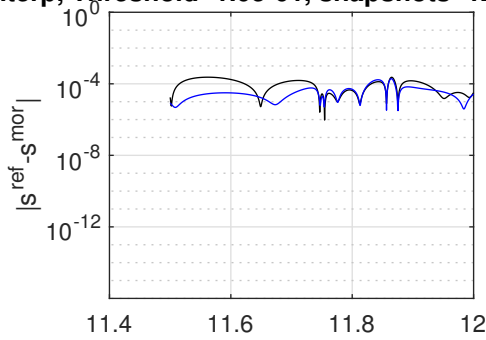

interp, Threshold=1.0e-01, snapshots=137892x36 Matlab - projekcja, Qsize=25

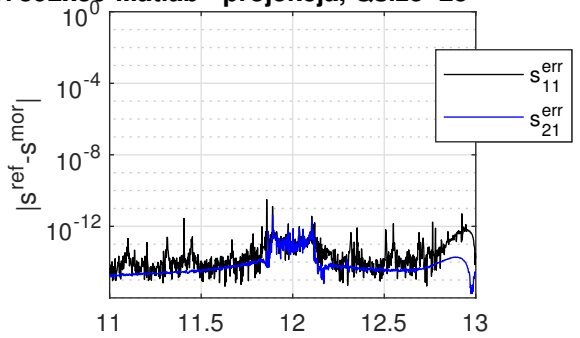
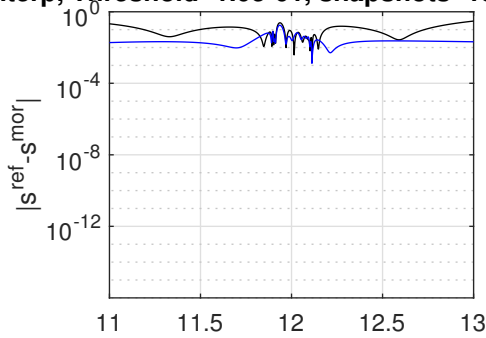

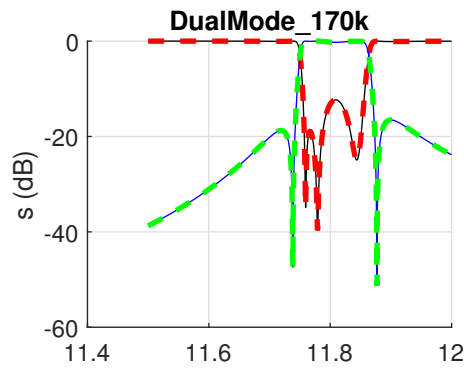

interp, Threshold=1.0e-02, snapshots=123288x26 Matlab - projekcja, Qsize=23

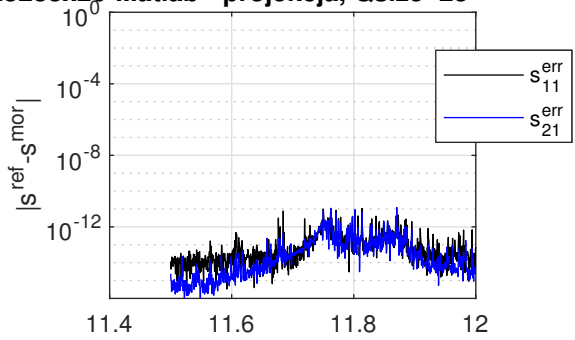
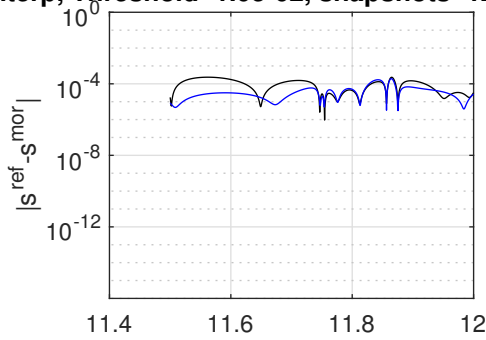

interp, Threshold=1.0e-02, snapshots=137892x46 Matlab - projekcja, Qsize=26

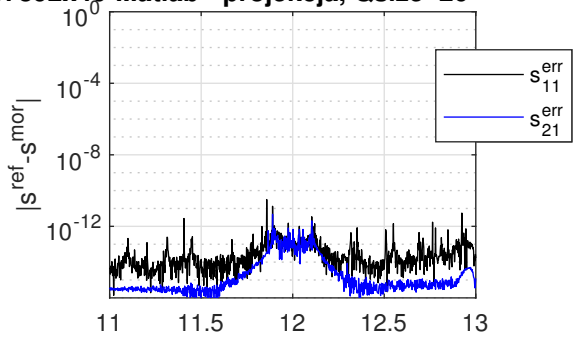
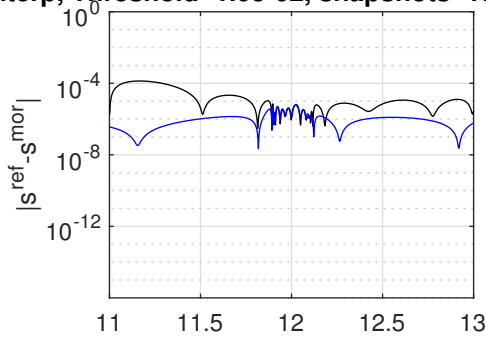

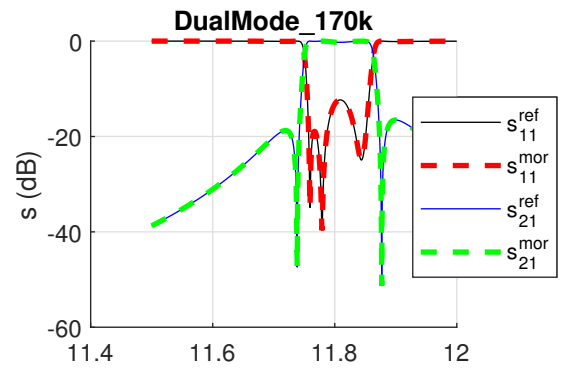
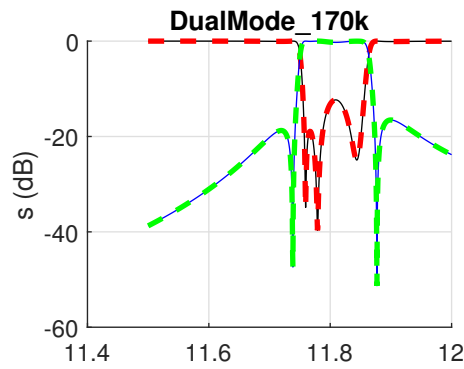

interp, Threshold=1.0e-03, snapshots=123288x30 Matlab - projekcja, Qsize=23

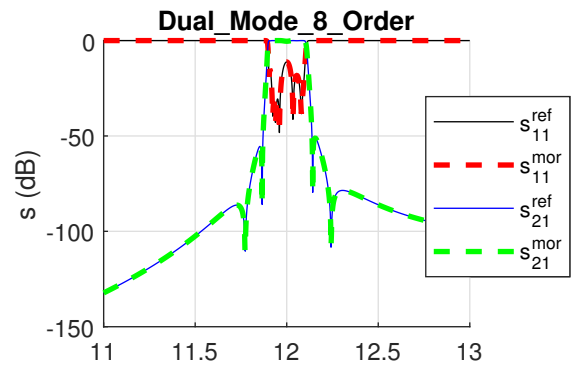
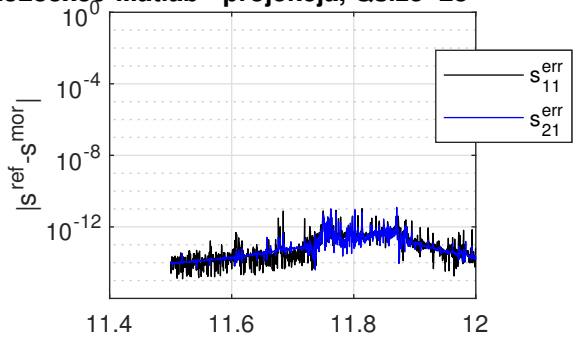
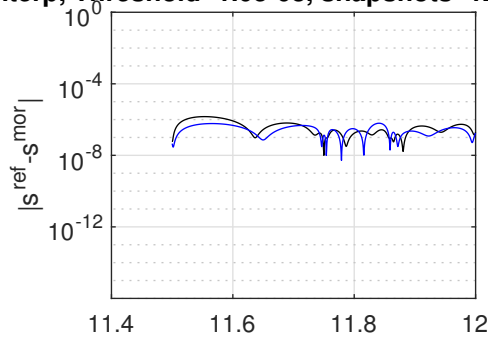

interp, Threshold=1.0e-03, snapshots=137892x50 Matlab - projekcja, Qsize=28

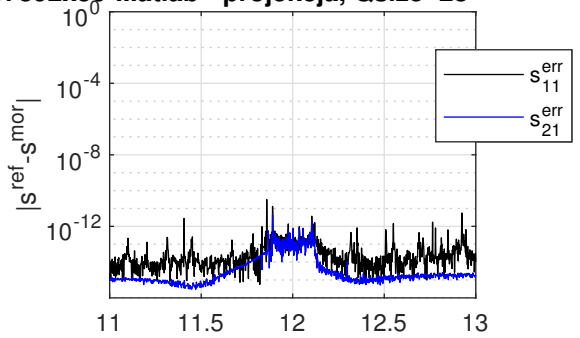
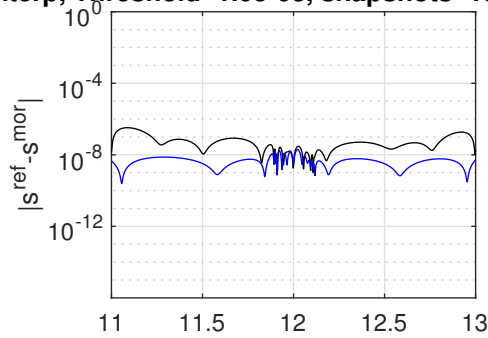

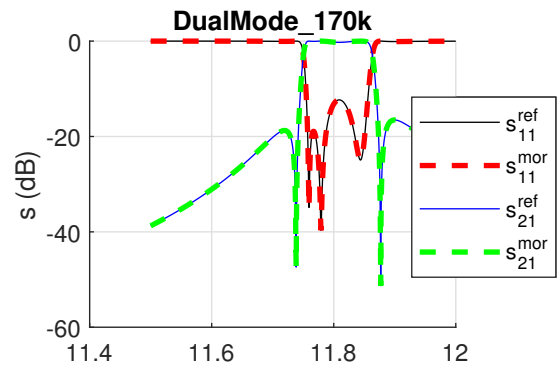
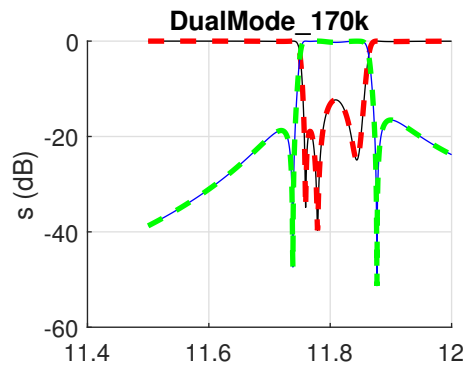

interp, Threshold=1.0e-04, snapshots=123288x34 Matlab - projekcja, Qsize=23

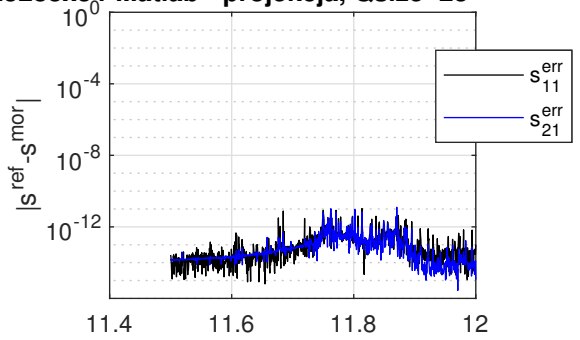
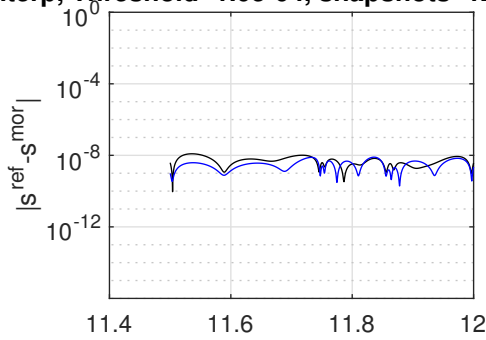

interp, Threshold=1.0e-04, snapshots=137892x50 Matlab - projekcja, Qsize=28

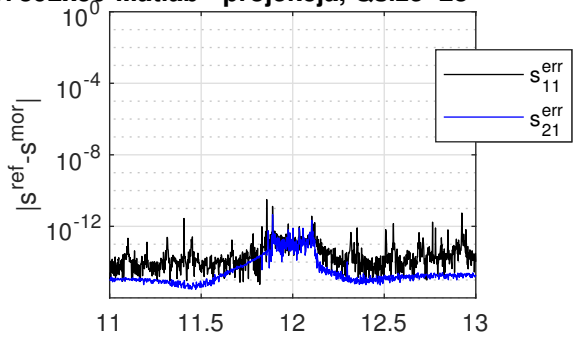
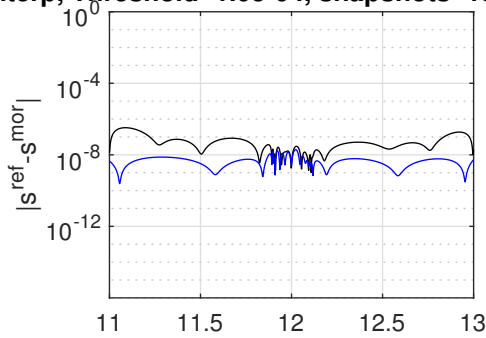

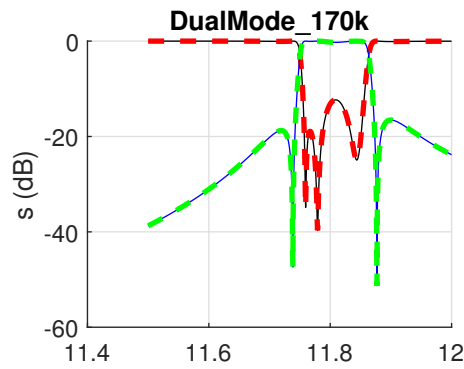

interp, Threshold=1.0e-05, snapshots=123288x34 Matlab - projekcja, Qsize=23

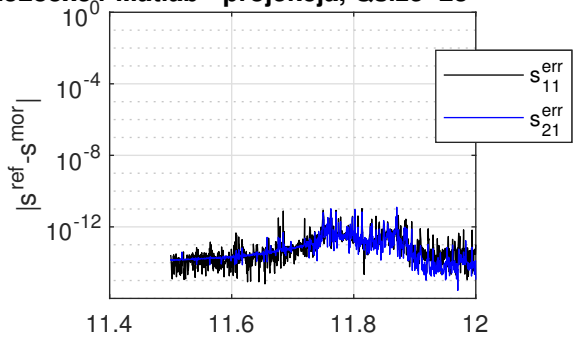
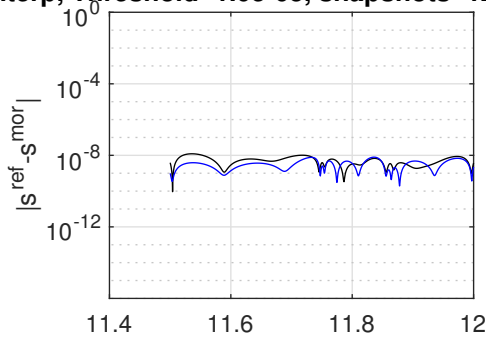

interp, Threshold=1.0e-05, snapshots=137892x54 Matlab - projekcja, Qsize=30

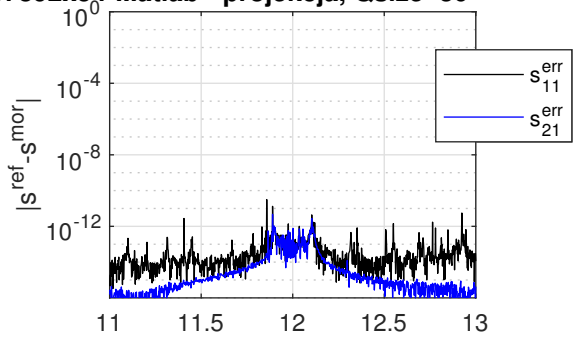
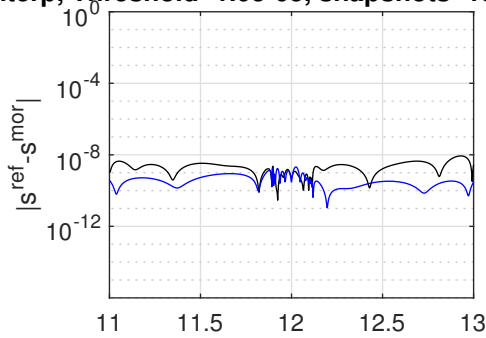

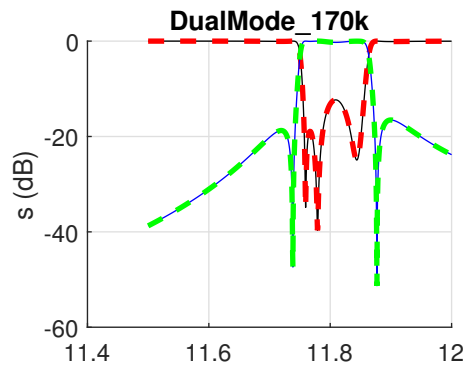

interp, Threshold=1.0e-06, snapshots=123288x34 Matlab - projekcja, Qsize=23

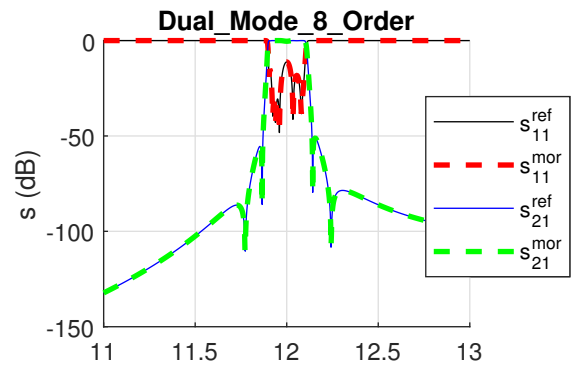
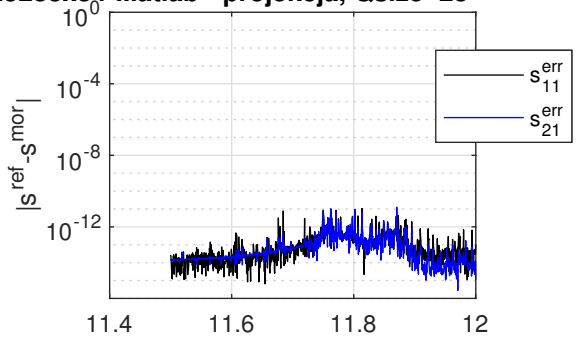
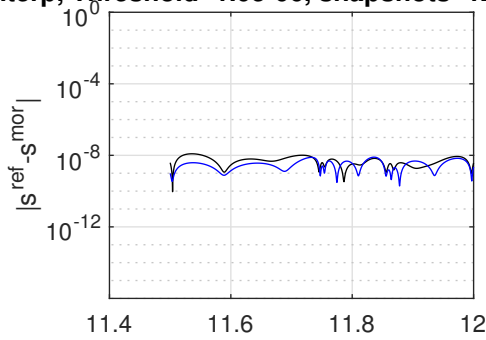

interp, Threshold=1.0e-06, snapshots=137892x54 Matlab - projekcja, Qsize=30

